

Настенный комнатный термостат

RDD310/MM

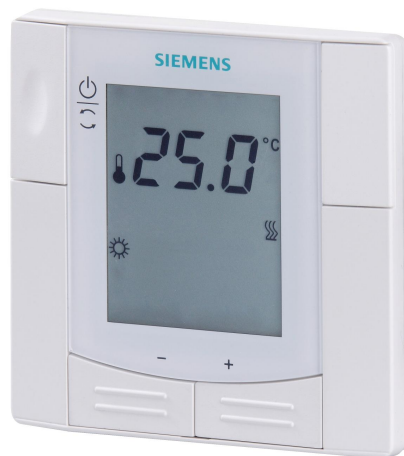

Designed for radiator and floor heating applications with either line contacts or dry contacts, and for wall-hung boiler applications with dry contacts.

- Operating modes: Comfort, Protection
- Adjustable commissioning and control parameters
- Optional display of room temperature or setpoint
- Minimum and maximum setpoint limitation
- Display temperature in increments of 0.5 °C
- Operating voltage AC 230 V
- Mounting on recessed square conduit box, fixed centers 60.3 mm
- User and parameter settings can be retained or restored with power loss

Применение

Room temperature control in a heating system:

Typical applications in ...

- Apartments
- Commercial buildings
- Schools

For the control of the following equipments and applications:

- Thermal valves or zone valves
- Gas or oil boilers
- Floor heating
- Radiator heating

Функции

- Selections of operating mode: comfort mode and protection mode
- Maintenance of room temperature with integrated temperature sensor
- Output for 2-position (on/off) valve actuator or SPDT (on/off) valve

Конструкция

Термостат состоит из двух частей:

- Передняя панель с электроникой, элементами управления и встроенным датчиком температуры в помещении.
- Монтажное основание с силовой электроникой. На монтажной плите сзади находятся винтовые зажимы. Термостат монтируется в прямоугольную распределительную коробку с центрами крепления на расстоянии 60,3 мм. Передняя панель устанавливается на монтажной плите и крепится с помощью защелки.

Элементы управления.

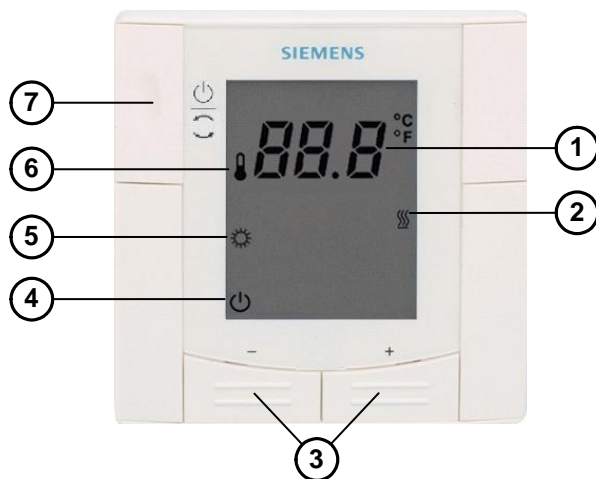

RDD310/MM User Interface

- | | |
|---|--|
| 1 | Protection mode |
| 2 | Нагрев |
| 3 | Buttons for adjusting the temperature setpoints and control parameters |
| 4 | Protection mode |
| 5 | Comfort mode |
| 6 | Symbol for actual room temperature |
| 7 | Button for Protection mode and mode selection |

Ordering











Type	Stock number	Designation
RDD310/MM	S55770-T358	Room thermostat

Delivery

Valve actuators should be ordered separately.

Equipment combinations

On/Off actuators

Type of units		Product number	Data Sheet
Electromotoric ON/OFF valve and actuator (only available in AP, UAE, SA and IN)		MVI.../MXI...	N4867
Electromotoric ON/OFF actuator		SFA21...	N4863
Thermal actuator (for radiator valve) AC 230 V, NO		STA23...	N4884
Thermal actuator (for radiator valves) AC 24 V, NO		STA73...	N4884
Thermal actuator AC 230 V (for small valves 2.5 mm) , NC		STP23...	N4884
Thermal actuator AC 24 V (for small valves 2.5 mm), NC		STP73...	N4884
Zone valve actuators (only available in AP, UAE, SA and IN)		SUA...	N4832
Damper actuator		GDB...	N4634
Damper actuator		GSD...	N4603
Damper actuator		GQD...	N4604
Rotary damper actuator		GXD...	N4622

Title	Document ID
Mounting Instructions	CB1M3066.1xx
Operating Instructions	CB1B3066.1xx
CE declarations	CB1T3066.1xx
Environmental declarations	CB1E3066en

All the documentations can be downloaded at the following Internet address:
<http://siemens.com/bt/download>.

Notes

Security

	<p>⚠ CAUTION</p>
	<p>National safety regulations Failure to comply with national safety regulations may result in personal injury and property damage</p> <ul style="list-style-type: none"> • Observe national provisions and comply with the appropriate safety regulations.

Mounting

Mount the thermostat on a recessed square conduit box with fixed centers of 60.3 mm. The mounting location on a wall should not be in niches or bookshelves, not behind curtains, above or near heat sources and wind outlet or inlet, and not exposed to direct radiation. Mounting height is about 1.5 m above the floor.

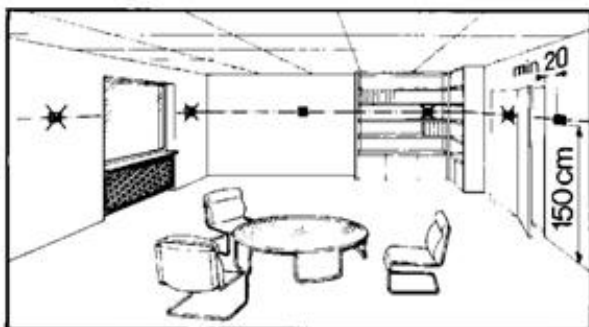

Refer to the Mounting Instructions CB1M3066.1xx enclosed with the thermostat.

	<p>⚠ WARNING</p>
	<p>Wiring, protection and earthing must be installed in compliance with local regulations. No internal line protection for supply lines to external consumers (Q11, Q12, Q14). Risk of fire and injury due to short-circuits!</p> <ul style="list-style-type: none"> • The AC 230 V mains supply line must have an external circuit breaker with a rated current of no more than 10 A. • Adapt the line diameters as per local regulations to the rated value of the installed overcurrent protection device. • Only use valves rated for AC 24...230 V. • Disconnect from supply before opening the cover.

After power up, the thermostat reset and all LCD segments flash, indicating that the reset is successful. This takes about 3 seconds. Then, the thermostat is ready for commissioning by qualified HVAC staff.

The control parameters of thermostat can be adjusted to ensure optimum performance of the entire system (see "Parameter settings").

Calibrating the sensor

If the displayed room temperature does not match the actual temperature, you can calibrate the temperature sensor by modifying the parameter P07.

Setpoint and range limitation

For the purpose of energy saving, it is suggested to review the setpoints and setpoint ranges (parameters P03, P05 and P06). Change the setpoint to suit your individual needs.

Control sequence

Only heating sequence is available.

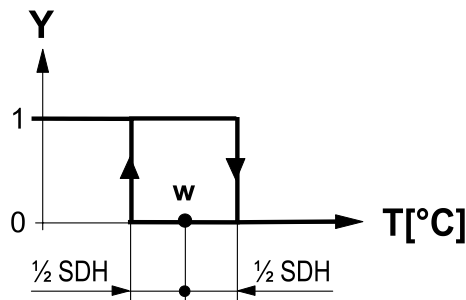

Control sequence

T[°C]	Room temperature	SDH	Switching differential "Heating"
W	Room temperature setpoint	Y	Control output "Valve"

ON

The valve receives the OPEN command via control output Q14 when both of the following conditions are met.

- The acquired room temperature lies by half the switching differential below the setpoint (heating mode)
- Control output Q14 is not energized for more than the "Minimum output off time" (factory setting: 1 minute)

OFF

The valve receives the CLOSE command via control output Q14 when both of the following conditions are met.

- The acquired room temperature lies by half the switching differential above the setpoint (heating mode)
- Control output Q14 is energized for more than the "Minimum output on time" (factory setting: 1 minute)



Control output Q11 delivers a control command which is inverted to the control command at output Q12 and which can be used for normally open valves.

Minimum output on/off time Q14 and Q12

The minimum output on/off time of Q14 and Q12 is 1 minute by default. It means that any readjustment of the setpoint will be hold for 1 minute before Q14 and Q12 react.

Parameter settings

To optimize the control performance, you can use local HMI to adjust a number of control parameters. All control parameter settings will be retained or restored with power loss.

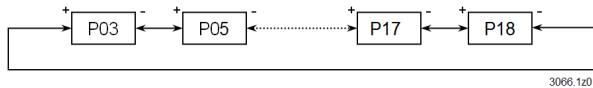

Proceed as follows to change the control parameters:

1. Set the thermostat to Protection Mode .
2. Press and hold down the + and - buttons simultaneously for 3 seconds.
 - Release the buttons, and within 2 seconds, press and hold down the + button for 3 seconds.
 - ⇒ **P03** displays on the screen.
3. Select the required parameter by pressing the + or - button as follows:



4. Press the + and - buttons simultaneously.
 - ⇒ The current value of the selected parameter displays on the screen.
 - Press the + or - button to change the value.
 - Either press the + and - buttons simultaneously to confirm the change, or wait for 5 seconds to have the change saved automatically.
5. Repeat Step 3 through 4 to change more parameters.
 - ⇒ 10 seconds after the last pressing, all changes are saved and the thermostat returns to protection mode.

Parameter reset

1. Set the thermostat to Protection Mode .
 2. Press and hold down the buttons + and - simultaneously for 3 seconds.
 - Release the buttons, and within 2 seconds, press the operating mode selector button  twice.
- ⇒ **888** displays on the screen during the reloading process.

Control parameters

Parameter	Description	Setting range	Factory setting
P03	Setpoint of heating in Protection Mode	OFF, 5...40°C	8 °C
P05	Minimum setpoint limitation in Comfort Mode ($W_{minNorm}$)	5 °C... $W_{maxNorm}$	5 °C
P06	Maximum setpoint limitation in Comfort Mode ($W_{maxNorm}$)	$W_{minNorm}$...40 °C	35 °C
P07	Sensor calibration	-3...3 K	0 K
P08	Switching differential heating SDH	0.5...4 K	1 K
P17	Selection of °C or °F	°C or °F	°C
P18	Display of room temperature or setpoint	OFF: Setpoint ON: Room temperature	ON

Temperature control

The thermostat acquires the room temperature via its built-in sensor and maintains the setpoint by delivering 2-position valve control commands.

The switching differential is 1 K in heating mode (factory setting, adjustable via parameter P08).

Display

The current room temperature or the setpoint of the current operating mode (adjustable via parameter P18) displays on the screen. Factory setting is to display the current room temperature.

The heating symbol  displays when the heating output is active.

If you want to change the unit of room temperature and setpoint between °F and °C, configure the parameter P17.

Operating Mode

The thermostat provides both Comfort Mode and Protection Mode.

Comfort Mode

In Comfort mode, press the + / - buttons to maintain the heating setpoint.



For the purpose of energy savings, the setpoint setting range has a minimum limitation (P05) and a maximum limitation (P06).

Protection Mode

In Protection mode, the heating setpoint (adjustable via parameter P03) is maintained. Factory setting of heating setpoint is 8 °C.

Switching differential heating (SDH)

The temperature hysteresis range (adjustable via parameter P08) controls the activation/deactivation of heating output. Factory setting of SDH is 1 K.

Disposal



The device is considered an electronics device for disposal in terms of European Directive 2012/19/EU and may not be disposed of as domestic garbage.

- Dispose of the device through channels provided for this purpose.
- Comply with all local and currently applicable laws and regulations.

Warranty

Technical data on specific applications are valid only together with Siemens products listed under "Equipment combinations". Siemens rejects any and all warranties in the event that third-party products are used.

Technical data

Power supply	
Operating voltage	AC 230 V +10%/-15%
Frequency	50/60 Hz
Power consumption	Max. 3 VA

Input relay	
Control input Q11	AC 24...230 V
Rating	5 mA...4(2) A

Output relay	
Control output Q14 (N.O.) / Q12 (N.C.)	AC 24...230 V
Rating	5 mA...4(2) A

Operational data	
Switching differential - Heating mode	0.5...4 K (factory setting: 1 K)
Setpoint setting range - Comfort mode - Protection mode	5...40 °C (factory setting: 20 °C) OFF, 5...40 °C (factory setting: 8 °C)
Built-in room temperature sensor - Measuring range - Accuracy at 25 °C - Temperature calibration range	0...49 °C <±0.5 K ±3.0 K
Resolution of settings and display - Temperature setpoints - Current temperature value displayed	0.5 °C 0.5 °C

Ambient conditions and protection classification	
Classification as per EN 60730 - Devices of safety class - Pollution class	II II
Degree of protection of housing to EN 60529	IP30
Climatic ambient conditions - Storage as per EN 60721-3-1 - Transport as per EN 60721-3-2 - Operation as per EN 60721-3-3	Class 1K3 Temperature -25...60 °C Humidity <95% r.h. Class 2K3 Temperature -25...60 °C Humidity <95% r.h. Class 3K5 Temperature 0...50 °C Humidity <95% r.h.

Standards, directives and approvals	
EU conformity (CE)	CB1T3066.1xx
RCM conformity	CB1T3066en_C1
Environmental compatibility	The product environmental declaration (CB1E3066en) contains data on environmentally compatible product design and assessments (RoHS compliance, materials composition, packaging, environmental benefit, disposal).
Eco design and labelling directives	Based on EU Regulation 813/2013 (Eco design directive) and 811/2013 (Labelling directive) concerning space heaters, combination heaters, the following class apply: Application with On/Off operation of a heater Class I value 1%

All the documentations can be downloaded at the following Internet address:
<http://siemens.com/bt/download>.

General	
Connection terminals	Solid wires or prepared stranded wires: 1x0.4-1.5 mm ²
Weight	0.17 kg
Color of front housing	White, RAL 9003

Diagrams

Connection terminals

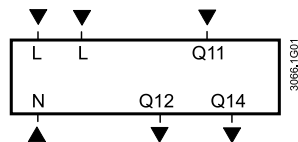

L, N	Operating voltage AC 230 V
Q11	SPDT Relay Input (Dry Contacts) AC 24...230 V
Q12	SPDT Relay Normal Close (NC) Output AC 24...230 V
Q14	SPDT Relay Normal Open (NO) Output AC 24...230 V

Connection diagrams

**Floor/Radiator heating
AC 230 V**

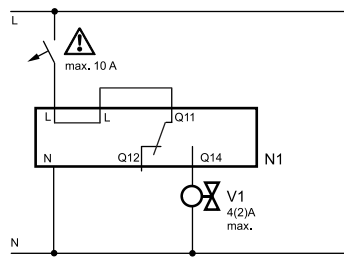

L, N Operating voltage
AC 230 V

V1 Valve AC 230 V

**Wall-hung boiler
AC 230 V**

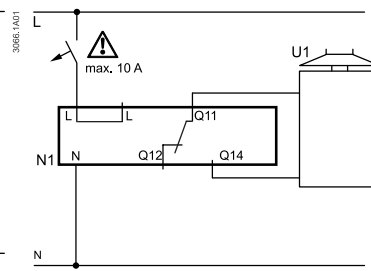

N1 RDD310/MM

U1 Wall-hung boiler

**Floor/Radiator heating
AC 24 V**

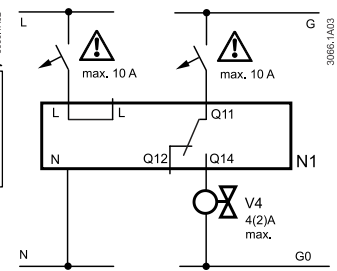

G, G0 Operating voltage AC 24 V

V2 Valve AC 24 V

Application examples

The thermostat supports the heating applications:

- Floor heating
- Radiators
- Wall-hung boilers

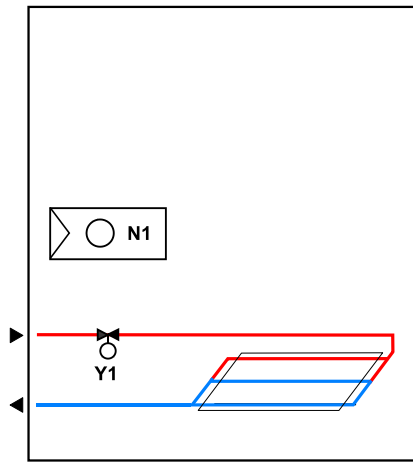

Room thermostat controls the valve of the floor heating or radiator application

N1 Room thermostat RDD310/MM

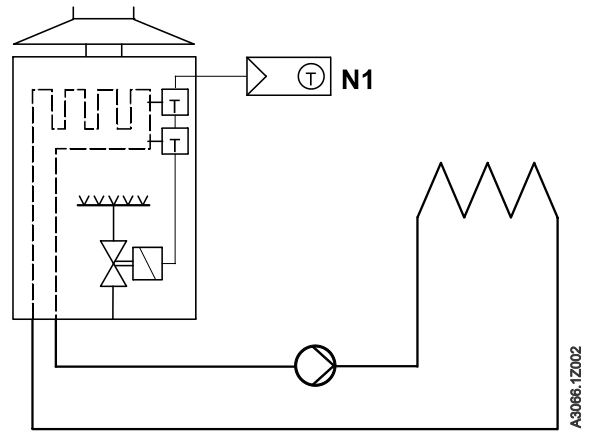

Room thermostat directly controls a gas-fired wall-hung boiler

Y1 2-port valve

Dimensions

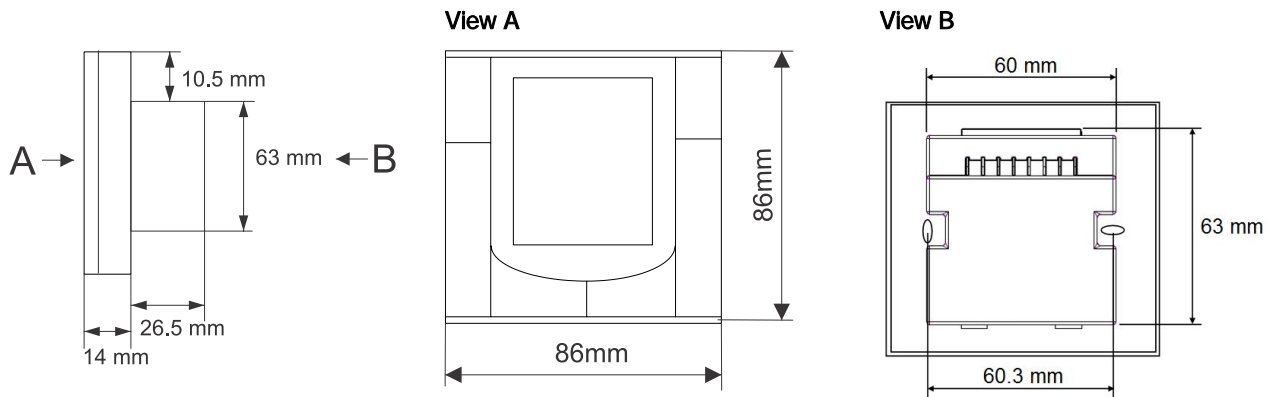

Issued by
Siemens Switzerland Ltd
Building Technologies Division
International Headquarters
Gubelstrasse 22
CH-6301 Zug
Tel. +41 41-724 24 24
www.siemens.com/buildingtechnologies

© Siemens Switzerland Ltd, 2015 - 2016
Technical specifications and availability subject to change without notice.